

## USER GUIDE

### LED LIGHTED MIRROR



Model: 62502448, 62504824

# IMPORTANT SAFETY INFORMATION

Please read through this installation instruction so you will know how to install and operate your model properly. Keep this document in a safe place for future reference after use.

## **WARNING**

This product must be installed in accordance with the installation instruction by qualified technician. Failure to follow instruction could result in death or serious bodily injury.

## **CAUTION**

This product must be serviced by qualified personnel. ALWAYS unplug the power cord or turn off the circuit breaker before service.

# PACKAGE CONTENTS

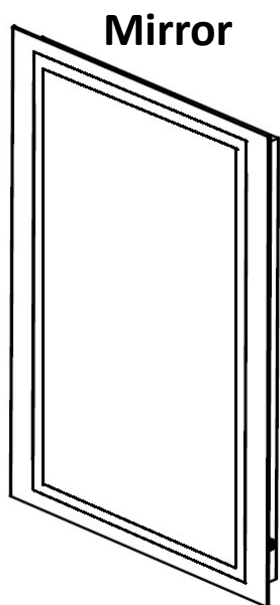

**Mirror**

(x1)

**Mounting Bracket**

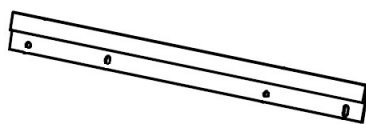

(Model 62504824 x2)

**Screw**



(Model 62504824 x8)

**Drywall Anchor**



(Model 62504824 x8)

# INSTALLATION

1

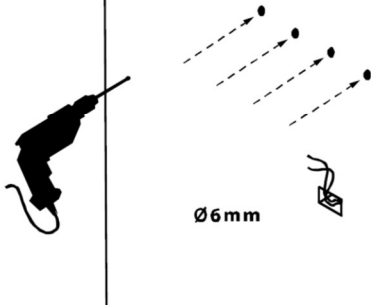

Ø6 mm

For drywall installation, mark the hole locations and drill  $\Phi$  6mm holes for the drywall anchors. Install a junction box behind the mirror for power connections.

2

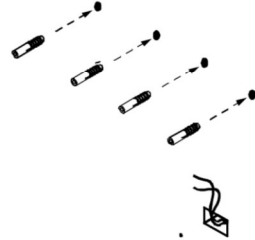

Insert provided drywall anchors.

3

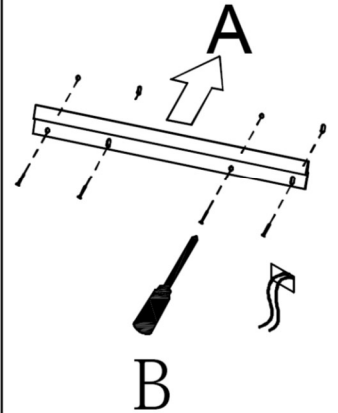

Install the mounting bracket.

4

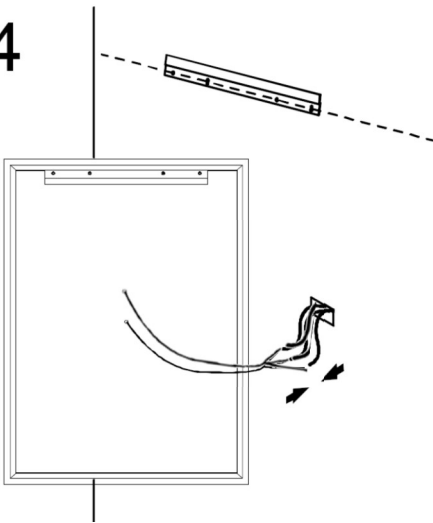

Connect the load (black) wire of the Dimming driver cable (white) to wall switch if used. Connect the load (black) wire of the Touch Switch cable (black) to hot wire.

5

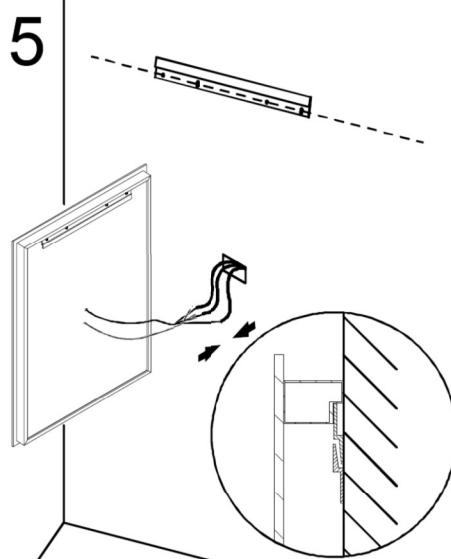

Hang the mirror to the wall and make sure the bracket in the back of the mirror lineup with the mounting bracket properly.

6

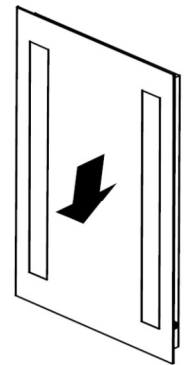

Press the mirror down slightly and make sure the brackets fit properly.



- Using the wall studs to hang the mirror is highly recommended.

# INSTALLATION DIMENSIONS

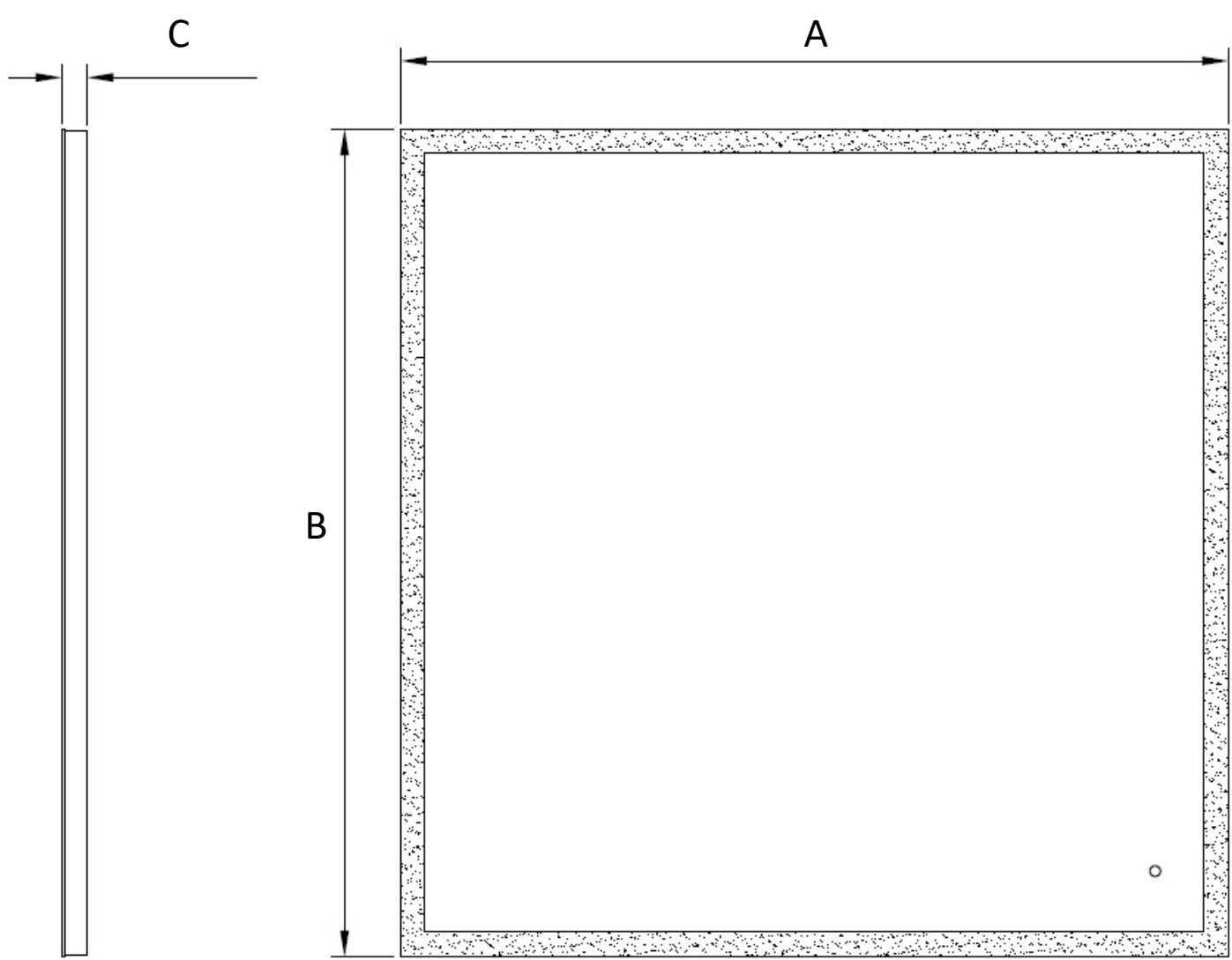

Model #	A	B	C
62502448	24	48	1 1/4
62504824	48	24	1 1/4

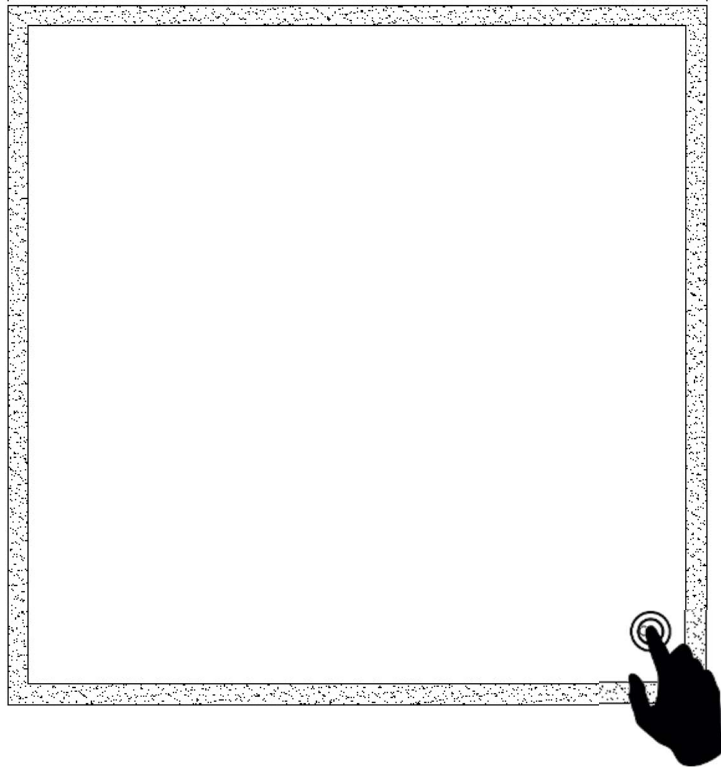

## 1. Touch switch

- a. Press the switch once to turn on/off the LED lights.
- b. When the lights are on, press and hold the switch for about 3 seconds to change the color temperature.

## CARE AND MAINTENANCE

Clean the mirror with a soft, damp cloth and dry thoroughly with a soft towel. Do NOT allow the edges of the mirror to get or remain wet over a period of time. Please do NOT use glass cleaner that contains ammonia or vinegar. Never spray any cleaner directly onto a mirror. Instead apply the cleaner to a soft cloth and then wipe the mirror. Make sure no commercial cleaner comes in contact with the edge or backing.

## WARRANTY

### 5 years Limited Warranty

**innoci usa** LED mirrors (Illumirror®) have been manufactured under the highest standards of quality and workmanship. We warrant to the original purchaser that our LED mirrors are free from any defects in material and workmanship by normal use for 5 years from date of purchase. A replacement for any defective part will be supplied FREE OF CHARGE for installation by you.

This warranty is valid to the original purchaser only and does not cover product damage due to installation error, product abuse, product misuse, etc. whether or not performed by professionals. **innoci usa** will not be responsible for labor charges and/or damage incurred in installation, repair or replacement nor for any incidental or consequential damages.

All warranty claims should be sent to [customerservice@innoci-usa.com](mailto:customerservice@innoci-usa.com) or call 1.866.479.8076. Our customer service representative will contact you promptly to help you go through the process until you are completely satisfied with our products.

**SHORTAGE OR DAMAGED PRODUCTS** All shipments are carefully inspected and counted before leaving our distribution centers. Please inspect carefully on receipt of merchandise, noting any discrepancy or damage on the carrier's freight bill at that time, and file a claim with the carrier within 10 days from receipt of order. Then contact our office. Deductions from invoices for shortages or damage claims will not be allowed.

**RETURN NEW GOODS** All claims for returns or adjustments must have prior approval and return authorization (RA) number. Only original, sealed product in salable condition are eligible for return. Credit for authorized returns will be issued at the net price paid for the product and subject to a 15% restocking/handling fee. Merchandise is to be returned via prepaid freight. All unauthorized returns will be refused or subject to a 25% restocking/handling fee.

To request an "RA" number: Contact our Customer Service Representatives at [customerservice@innoci-usa.com](mailto:customerservice@innoci-usa.com). We will send you a Return Authorization Number (RA) by return email. Please take necessary precautions when returning merchandise to prevent additional damage. Insurance is the responsibility of the shipper.

# Exploded view

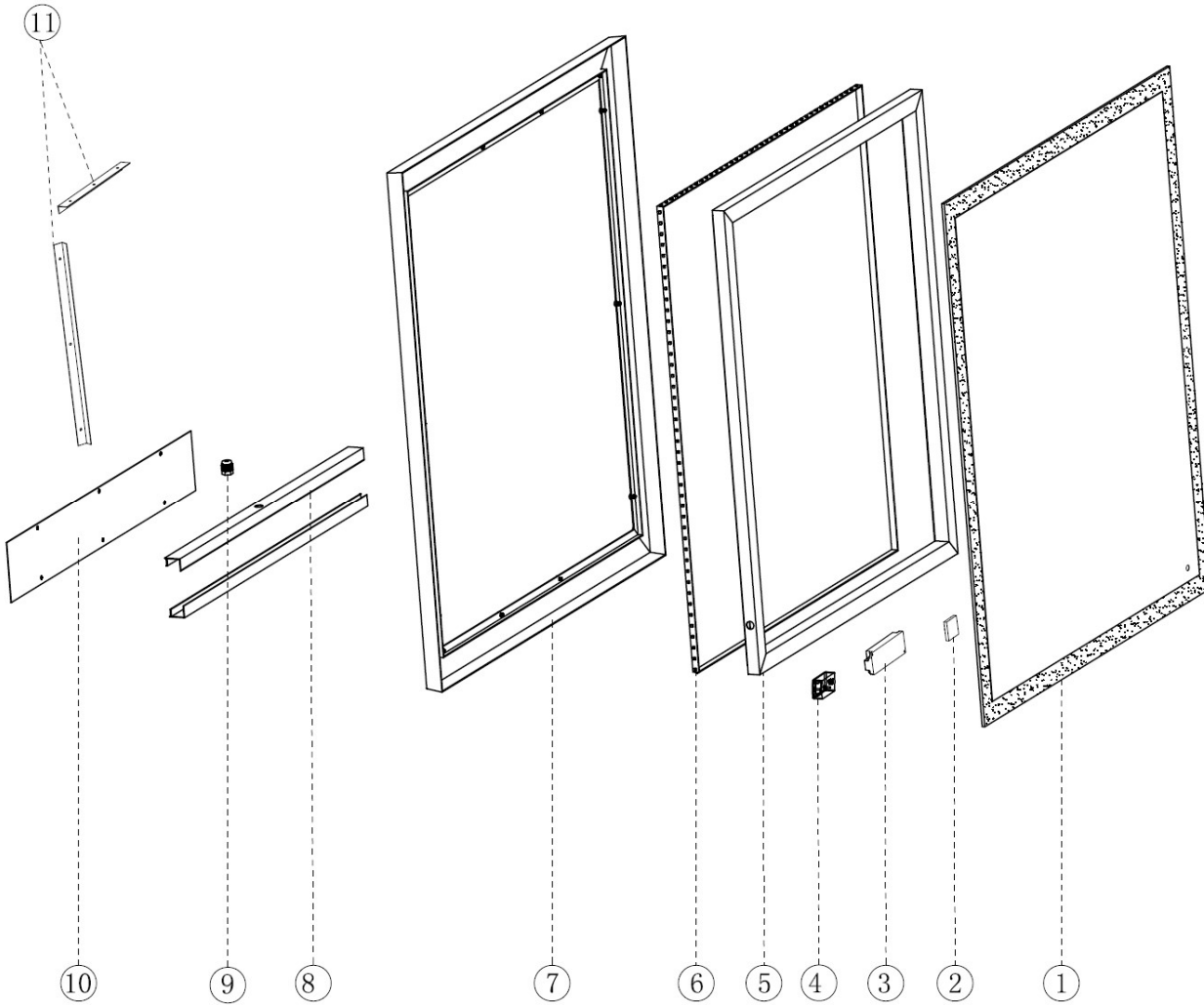

Part	Description
1	Mirror
2	Touch Switch
3	LED Driver
4	Touch Switch Box
5	Aluminum Frame-inner
6	LED Strip
7	Frame-outer
8	Support
9	Cable Gland
10	Galvanize Plate
11	Mounting Bracket

**innoci usa, Inc.**

14530 Best Ave.,  
Santa Fe Springs, CA 90670

[www.innoci-usa.com](http://www.innoci-usa.com)